

Section 2 Innovation of Techniques for Creating Science, Technology and Innovation in a Super Smart Society

Section 2 describes the future direction of Japan's efforts concerning the following: the open innovation that is necessary for successively creating new businesses and services; and the systems that need to be improved or reformed for innovation (e.g., systems related to regulations, cybersecurity, and the protection of personal information and intellectual property).

As increases in data-driven research and open science show, the advancement of ICT has resulted in changes in the techniques for creating STI. Thus, the future direction of Japan's efforts is also elaborated on below.

1 A Super Smart Society and Open Innovation

In a super smart society, the value chains that are developed and used separately in each of the various sectors of society will be expanded and integrated to provide advanced services to every member of society. To realize such services, infrastructure for facilitating innovation should be put in place by securing the openness of business beyond the boundaries of different business types or categories, and by creating broad-ranging partnerships among stakeholders from industry, academia and government.

As demonstrated by the Industrial Internet Consortium (IIC) in the U.S.A. and Industrie 4.0 in Germany, efforts to create such infrastructure through public-private partnerships are well under way in other countries. Japan needs to enhance similar efforts by reinforcing industry-academia government collaboration.

To promote open innovation, it is important to increase opportunities for each player in industry and academia to capitalize on their respective strengths and to link and merge their diverse strengths in a complementary manner. In a society where game changes are frequent, venture companies play significant roles, as these companies have the potential to act swiftly and try out practical applications expeditiously.

(1) Reinforcement of the systems that support the realization of a super smart society

In October 2015, the IoT Acceleration Consortium was established, with the aim of creating an environment for attracting IoT-related investment from home and abroad and for the purpose of enhancing the presence of Japan's IoT-related industries in the world economy¹. To this end, the IoT Acceleration Consortium works on developing and demonstrating IoT-related technologies as well as creating new business models. This consortium is chaired by Professor Jun Murai, Dean of the Faculty of Environment and Information Studies, Keio University.

The IoT Acceleration Consortium consists of the following.

- The Technology Development WG for the development, demonstration and standardization of IoT-related technologies and networks (also called the Smart IoT Acceleration Forum)

¹ Prospectus of the IoT Acceleration Consortium (Professor Jun Murai, Dean of the Faculty of Environment and Information Studies, Keio University, Hiroo Unoura, President, Nippon Telegraph and Telephone Corp., Hiroaki Nakanishi, Chairman and CEO, Hitachi, Ltd.)

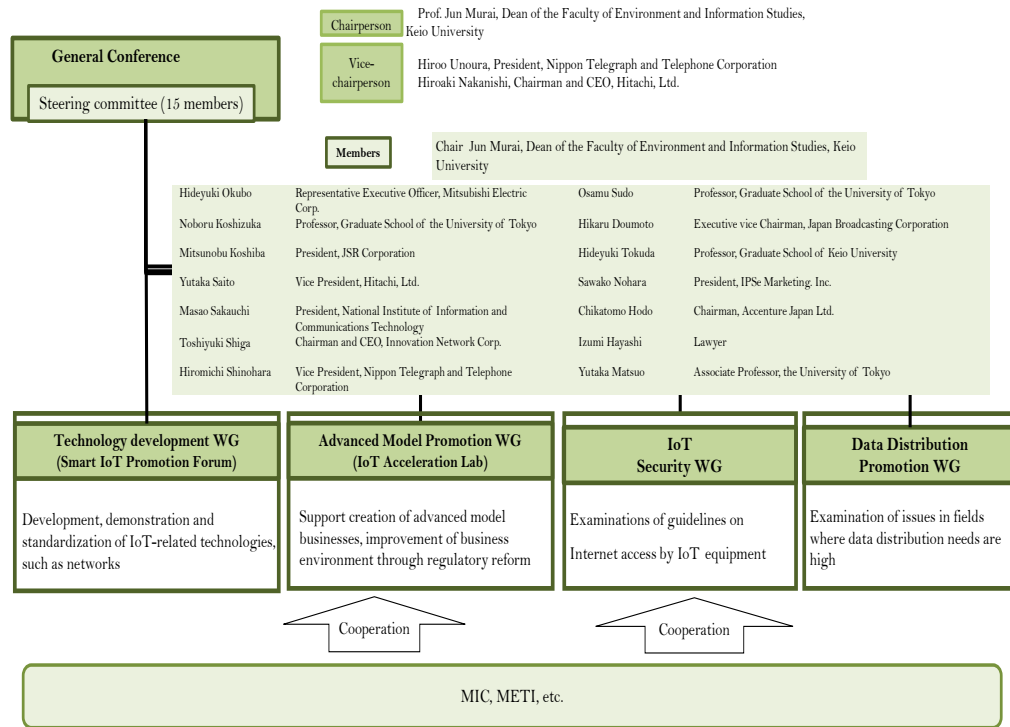

The IoT Acceleration Consortium

Source: The IoT Acceleration Consortium

- The Advanced Model Business WG for the creation of advanced model businesses and the improvement of the business environment, including by regulatory reform (IoT Acceleration Lab)
- Technical working groups for specific issues, such as security and personal information (the IoT Security WG, and the WG for Promoting Data Distribution)

Consisting of about 1,000 member companies, the IoT Acceleration Consortium has been engaging in the development and demonstration of advanced technologies and in the drafting of policy proposals regarding regulatory reform. Specific activities of the WGs are as follows.

<Technology Development WG (Smart IoT Acceleration Forum)>

The Smart IoT Acceleration Forum, chaired by Professor Hideyuki Tokuda of Keio University, was organized to promote the development and demonstration of IoT-related technologies. This WG consists of the Study Group on Technology Strategy and the Group on Research, Development and Demonstration Projects. The former group works on strategies for the development, demonstration, standardization and globalization of these technologies. The latter group is dedicated to promoting shared basic technologies of the IoT and systems, robots, etc. featuring autonomous mobility. Sub-groups of these two groups engage in investigations in further detail.

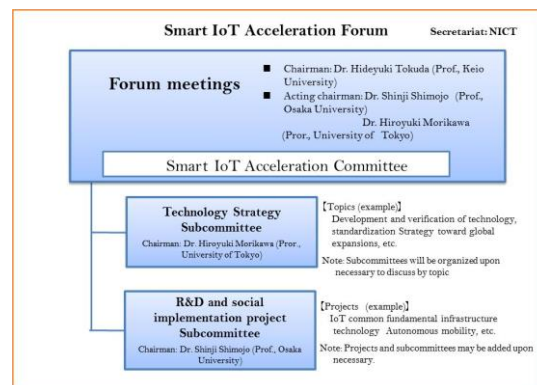

Structure of the Smart IoT Acceleration Forum

Source: MIC

For example, the Sub-group on Testbeds, one of the

sub-groups of the Study Group on Technology Strategy, conducts studies on the requirements of testbeds that help enhance the demonstration and social validation of technologies and on the use promotion of such testbeds. Testbeds refers to platforms for testing new technologies and the like, and these platforms are used under conditions similar to the actual conditions under which such new technologies will be applied. Testbeds enable practical technologies to be verified with no risk of damage to existing systems in operation. Various sectors of industry have different types of testbeds. The National Institute of Information and Communications Technology (NICT), for example, has been developing a testbed for sensor networks. NICT developed JOSE (the Japan-wide Orchestrated Smart/Sensor Environment), an open testbed for field trials of large-scale IoT services. JOSE is both an open testbed and a service platform for the real-time processing and analysis of observation data from a large number of sensors located over a wide region, and field trials and verifications can be run on JOSE by utilizing the distributed computing resources at data centers that are linked by a high-speed network.

The effective use of testbeds facilitates a shift in R&D processes from a conventional linear model to a spiral model. In the linear model, a technology developed based on research is used for product development, and the results obtained by deploying and using the technology are fed back to R&D. In the spiral model, problems and necessary improvements can be identified and addressed at each stage of a technology's development and application. It is expected that the time span necessary for translating the results of R&D into practical applications will be significantly shortened in a super smart society. In this regard, the utilization of testbeds is effective for creating innovations in a timely manner.

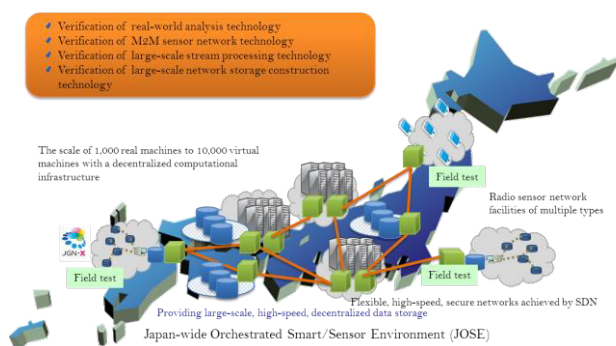

JOSE

Source: NICT

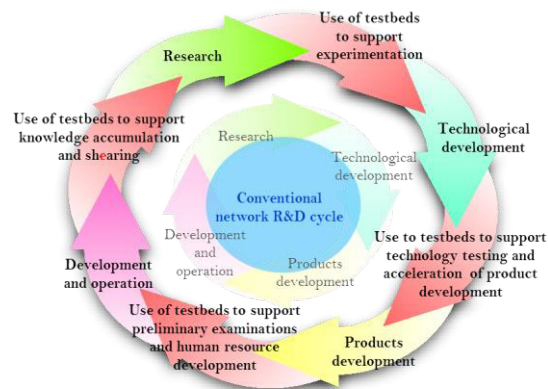

Use of testbeds to comprehensively support R&D

Source: NICT

<Advanced Model Business Promotion WG (IoT Acceleration Lab)>

The IoT Acceleration Lab, chaired by Kazuhiko Toyama, CEO of Industrial Growth Platform, Inc., was established as an industry-academia- government body for four purposes: i) to develop infrastructure for strengthening interfirm cooperation, ii) to provide financial support to IoT projects, iii) to contribute to rulemaking and regulatory reform related to IoT acceleration, and iv) to present recommendations to the government to help formulate sectoral strategies for accelerating the IoT. The IoT Acceleration Lab's Support Committee provides advice to various projects related to the IoT, big data and AI, and puts together recommendations regarding regulatory reforms that are necessary for implementing these

projects. (More than half of the 25 members of the Support Committee are from foreign-affiliated companies.)

As part of its initial efforts, the IoT Acceleration Lab has been implementing the following: the IoT Lab Selection scheme for scouting for and selecting advanced IoT projects; IoT Lab Connection (Solution Matching) events for matching enterprises, associations and local governments with each other; and the Big Data Analysis Contest, in which prizes are awarded to superior online algorithms developed by using big data on tourism provided by private companies.

Under the IoT Lab Selection scheme, the government and the private sector (i.e., government agencies, banking institutions and venture capital firms), which aim to create IoT business models as well as to discover and foster IoT platformers, work together to identify and recognize advanced IoT projects that are eligible for the following support.

<Short-term financial support>

- The provision of risk capital as public support to the commercialization of IoT projects¹

<Mentoring>

- The provision of advice by mentors from private companies, IPAs, etc. who support new business launches

<Support related to regulatory reform and standardization>

- Support for each specific project for deregulation (by means of the System of Special Arrangements for Corporate Field Tests and the System to Remove Gray Zone Areas)
- Financial support for deregulation in each specific sector, support by mentor referral, and other support related to deregulation and standardization

The First IoT Lab Selection was conducted in February 2016. Of the 252 applicants for selection, the grand prize went to Liquid Marketing, Inc. (cf. Column 1-7).

IoT Lab Connection (also called Solution Matching) offers business events at which they can be matched with business operators who aim to create new business models. At the first matching event, held on the topic of Tourism and Manufacturing (Smart Factory), participants had about 550 one-on-one matching sessions of 15 minutes each.



IoT Lab Selection

Source: METI



Business-matching sessions

Source: METI

¹ Private companies, New Energy and Industrial Technology Development Organization (NEDO), Information-technology Promotion Agency, Japan (IPA)

Column
1-7

IoT Lab Selection Grand Prize winner: Liquid Marketing, Inc.
 Personal authentication of foreign tourists through fingerprints (for identification and payment)

Liquid Marketing, Inc. developed a biometric system for personal authentication through fingerprints only. Currently, it takes hundreds of seconds to authenticate one million fingerprints. The use of AI to classify fingerprint features has reduced that time to 0.05 seconds. By using the fingerprints of two fingers, the probability of incorrect authentication has been reduced to one in a trillion. With the cooperation of major hotels and other entities, Liquid Marketing, Inc. has been conducting demonstration tests of procedures for fingerprint authentication and payment at hotels and shops. (Foreign tourists do not have to show their passports or credit cards.) Liquid Marketing, Inc. seeks support from the IoT Lab Selection scheme in terms of financial assistance and help with deregulation of the Hotel Business Act (i.e., exemption from the obligation of keeping photocopies of hotel guests' passports).



Fingerprint authentication

Source: Liquid Marketing, Inc.

(2) Enhancement and practical application of basic technologies that support a super smart society

The basic technologies highlighted in Section 1 of Chapter 2 need to be enhanced towards achieving a high goal from a mid- to long-term perspective, and the further development of these basic technologies in a super smart society should also be considered. To ensure the smooth application of these technologies for facilitating innovation, infrastructure should be developed through industry-academia-government collaboration so that the development, practical application and commercialization of innovative technologies will be concurrently promoted. For this purpose, it is important to increase opportunities for industries and universities to capitalize on their respective strengths and to link and merge their strengths in a complementary manner.

The economic value generated from the commercialization of R&D results will contribute significantly to Japan's economic growth and job creation. In this regard, venture businesses initiated by universities are expected to play a particularly important role, because these businesses make use of the latest research results or innovative technology seeds and can swiftly translate these results and seeds into practical applications¹.

Entrepreneurial ventures of modest size

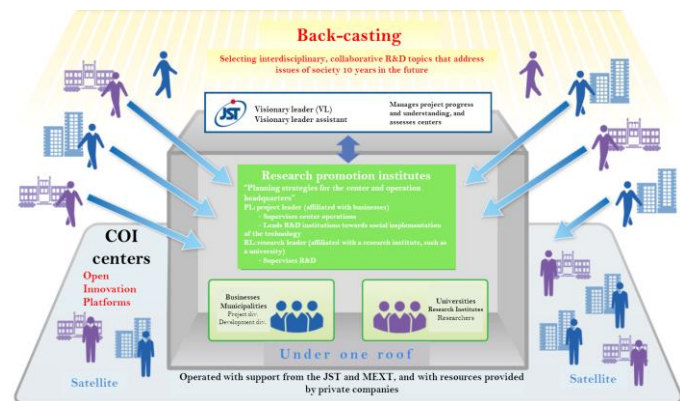

Outline of COI

Source: JST

¹ Entrepreneurial ventures of modest size that are flexible and quick in making decisions are better suited to innovation and the commercialization of technological seeds in a short period of time, in comparison to major companies, which tend to be subject to the restraints of market size and which need a relatively long time to make decisions.

that are flexible and quick in making decisions are better suited to innovation and the commercialization of technological seeds in a short period of time, in comparison to major companies, which tend to be subject to the restraints of market size and which need a relatively long time to make decisions. MEXT has been working with the Japan Science and Technology Agency (JST) to implement the Center of Innovation Science and Technology based Radical Innovation and Entrepreneurship Program (COI STREAM) with a view to establishing and operating a large, world-class R&D center through industry-academia cooperation. Starting by defining a desirable future for individuals and society 10 years from now (i.e., the Three Future Visions¹), this program provides support to ambitious, high-risk R&D projects (under a back-casting method) that need to be promoted across different sectors through the collaboration of multiple players, so as to connect the envisioned future to the present. In this program, the slogan “under one roof” represents the intention of establishing an innovation platform (COI Site) where universities and companies can work together on R&D.



Robotics × Future 2016

Source: JST

The JST is also responsible for the Program for Creating Start-ups from Advanced Research and Technology (START) for the purpose of helping to create ventures for commercializing technology seeds at universities. The START Program concurrently supports R&D on innovative technologies owned by universities and the development of businesses through mentoring by managers from private companies (project promoters²) who have the know-how to commercialize research results. This integrated support before the start of business is designed to help create university-launched ventures. Under the START Program, a project for selecting and developing technological seeds is implemented. This project aims to discover and foster technological seeds that were created by young researchers. For this purpose, young researchers are encouraged to produce prototypes to demonstrate the superiority and originality of their technological seeds to project promoters. In FY2015, applications for the project were accepted in the field of robotics, and prototype robots created by applicants were exhibited at Robotics × Future 2016. The IoT is the topic for prototype production under the project for FY2016.

¹ Vision 1: Securing sustainability as a country at the forefront of efforts to solve emerging issues of an aging society with fewer children: Smart life care and an ageless society

Key concepts (Function): Medical health, mental health, motivation, sports, food, and ties

Realization of happiness

Vision 2: Creating a living environment with a high quality of life in Japan as a prosperous and reputable country: Smart Japan

Key concepts (Function): “勘-ing” thinking (intuition), active thinking, serendipity, and the six senses

Innovating ways of thinking

Vision 3: Establishing a sustainable, vital society: Active sustainability

Key concepts (Function): Personalization, resilience, sustainability, functionalization, flexibility - waste

The development of a society that can sustain itself for centuries

² Project promoters are appointed in order to enhance integrated support for R&D and the commercialization of technological seeds at universities. These project promoters have expertise in commercializing research results; thus, they can effectively and efficiently support R&D and the commercialization of technological seeds.

2 System Improvement towards Realizing a Super Smart Society

To maximize the potential of science, technology and innovation to change the world in a super smart society, relevant existing systems need to be altered. In view of this, the ministries and agencies have been reviewing these systems.

(1) System improvements necessary for realizing a super smart society

People will enjoy more comfortable and convenient lives in a super smart society. However, there are issues that need to be addressed in the process of realizing such a society. These include the management of personal information and intellectual property contained in vast amounts of data, liability for accidents caused by AI robots, and measures against cyberattacks.

The government has been discussing and examining the following system improvements that are considered to be necessary for realizing a super smart society:

- System improvements necessary for enhancing the creation of innovative businesses, particularly with regard to systems related to the protection of personal information and intellectual property rights, and related to liability for incidents associated with AI.
- Infrastructure improvements necessary for ensuring a high level of security as well as for realizing safe living environments.

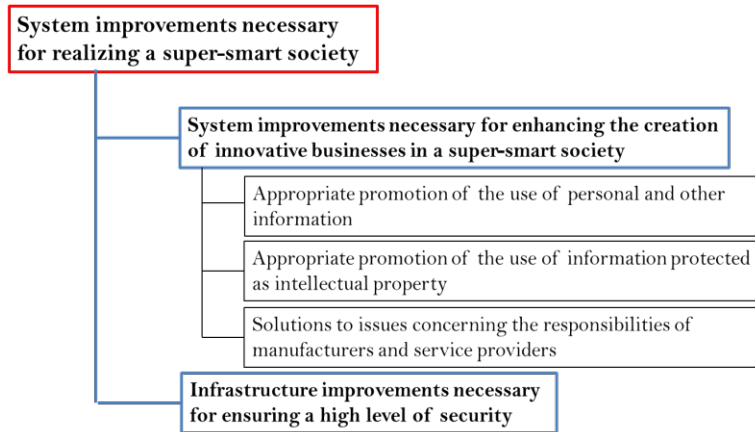

System improvements necessary for realizing a super smart society

Source: MEXT

① Appropriate promotion of the use of personal and other information

A variety of information on individuals is collected from diverse sources and stored in cyberspace. This information includes data that people do not want to others to collect, and information concerning individuals that was collected without their knowledge.

While this information in cyberspace can be compiled into various formats for distribution, it is not practical to get permission to use specific personal information from each of the many people who are included in big data.

Thus, in the process of realizing a super smart society, these issues should be considered in light of achieving the proper balance between the need to appropriately

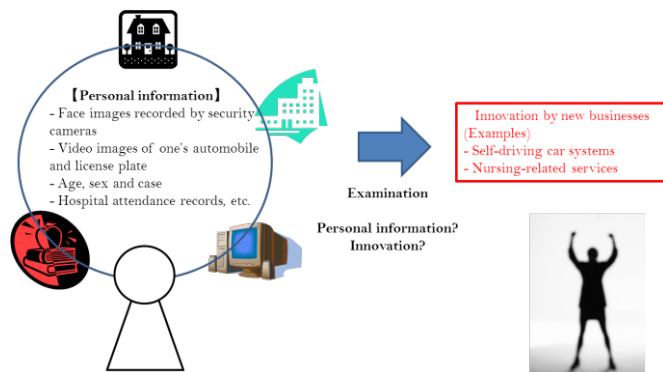

Innovation and the protection of personal information

Source: MEXT

promote the use of information and the need to protect the rights and interests of individuals.

For the purpose of investigating the system improvements necessary for smooth information distribution by utilizing information and communications technologies, the National Strategy Office of Information and Communications Technology, Cabinet Secretariat, established the Committee on System Improvements Related to the Use of Information and Communications Technology in October 2015. The Committee released an interim report in December 2015 and has been continuing various studies on the basis of public comments on the interim report. The interim report summarizes the basic directions of studies on the structure of the Agency (tentative) that will be responsible for the appropriate and efficient collection and analysis of vast amounts of diverse personal data and that will promote the use of such data for the purpose of properly enhancing the use of personal and other information. Specifically, the Agency will be responsible for “managing personal information on a contract basis” and “the collection and analysis of personal information.”

According to the interim report, in performing managing personal information on a contract basis, the Agency is commissioned by individuals to take control of, analyze and process their personal and other information (e.g., IDs, passwords, records of prescribed medication and credit card information).

In conducting the collection and analysis of personal information, the Agency collects and analyzes personal information that is kept by various private companies and government organs but is not fully utilized by them. By using AI to analyze big data, the Agency turns such data into assets on behalf of such companies and organs. In the field of medical care, for example, the Agency collects personal information from multiple medical institutions, anonymizes and analyzes the collected data and provides the analysis results of the anonymized data to medical facilities, universities and pharmaceutical companies. First-person informed consent is needed in principle for the collection of certain personal information from medical institutions. Such information needs attention, and the task of gaining the consent of many patients puts a lot of strain on medical institutions. In this regard, use of “opt-out” exceptions to the Act on the Protection of Personal Information is being considered in order to facilitate the collection of personal information by the Agency.

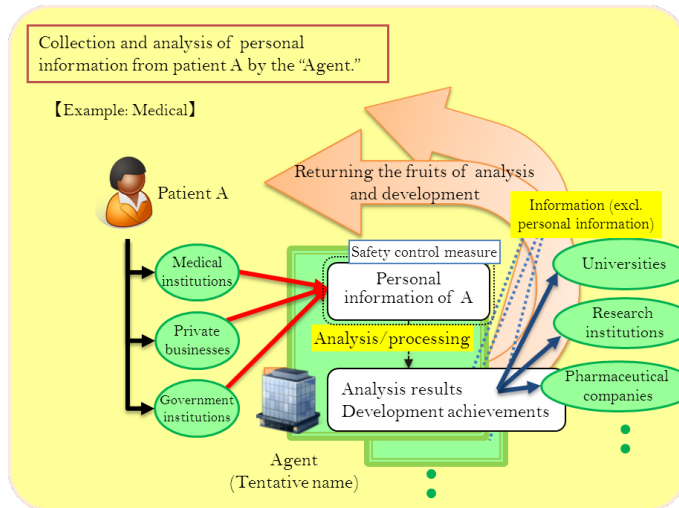

Collection and analysis of personal information by the “Agency”

Source: The First meeting of the Committee on System Improvements Related to the Use of Information and Communications Technology

In compiling the interim report, the members of the Committee on System Improvements Related to the Use of Information and Communications Technology discussed and agreed on the following: This opt-out exceptions should be available only when personal information is collected for medical care, nursing care, accident and disaster prevention, or other purposes for which public understanding can be obtained; the applicability of “opt-out” exceptions should be examined rigorously; and “opt-out” exceptions are applicable only when the collection of personal information is determined to cause no conflict with the protection of personal information.

② Appropriate promotion of the use of information protected as intellectual property

In a super smart society, vast amounts of personal and other information will be generated and collected. Such information is assumed to include created content and other information that is protected as intellectual property. Thus, it is necessary to consider how to make use of information in light of systems related to intellectual property rights. The Secretariat of Intellectual Property Strategy Headquarters (Committee on Next-generation IP Systems), Cabinet Secretariat, has been addressing this issue from various viewpoints. Four key points under consideration:

<The protection of intellectual property and the creation of innovations>

With the advancement of digital networks, new businesses are expected to deal with increasingly large amounts of information. When copyrighted

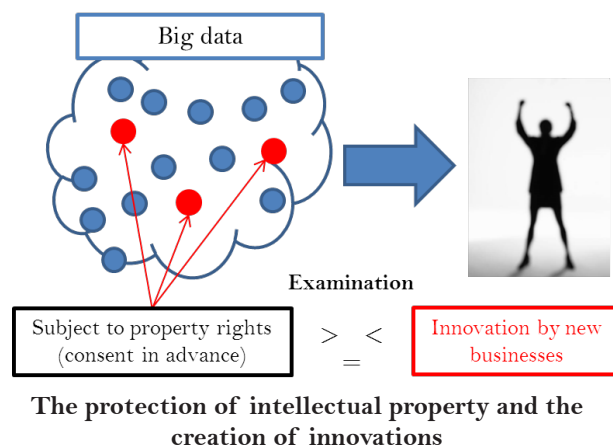

The protection of intellectual property and the creation of innovations

Source: Created by MEXT based on materials used by the Committee on Next-generation IP Systems

information is included in such information, permission for the use of the copyrighted information should be obtained in advance. However, it is difficult to obtain prior permission from all copyright holders when enormous amounts of unspecified information need to be dealt with. In light of this, the development of an IP system that takes into account the use of copyrighted works is being considered in order to maintain a balance between the need to protect intellectual property and the need to create innovations.

<The protection of databases>

Under the current system, databases that were developed by using creativity are protected as intellectual property, because people compile databases by exercising their ingenuity in selecting the information that they deem necessary and in organizing the selected information in a systematic way that they consider appropriate.

In a super smart society, AI is expected to build databases without the help of people in processing information. Ways of protecting these databases under the intellectual property system are being considered.

<Ways of dealing with the creations of AI>

Under the current intellectual property system, intellectual property rights are protected for human creations but not for AI creations that do not involve the assistance of a human. With the innovative advancement of AI, it will be increasingly difficult to distinguish the creations of AI from the creations of people. Unless someone who was involved in making an AI creation testifies that it is “the creation of an AI,” that creation is likely to be equated with the creation of a person.

No one, other than the relevant intellectual property rights holder, is allowed to make free use of information that is protected as intellectual property. There is a concern that persons who have access to AI (e.g., developers and owners of AI) could monopolize information if AI creations were treated the same as human creations.

Because autonomous creative activities by AI have the potential to generate innovations or culture, it is hoped that new approaches will be developed for creative activities through collaboration between humans and AI.

In view of this, ways of dealing with AI creations within the framework of the intellectual property system are being examined by taking into account the need to protect and promote investment in AI as

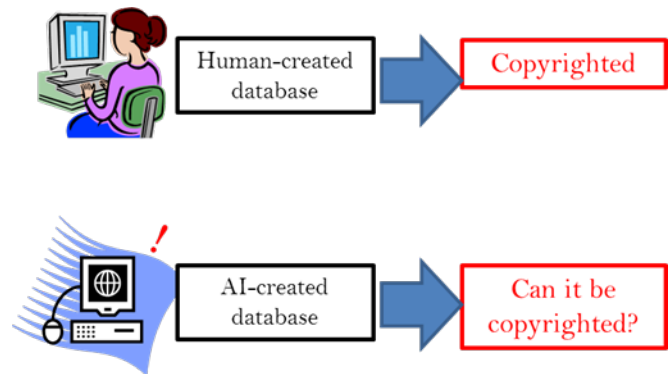

The protection of databases

Source: Created by MEXT based on materials used by the Committee on Next-generation IP Systems

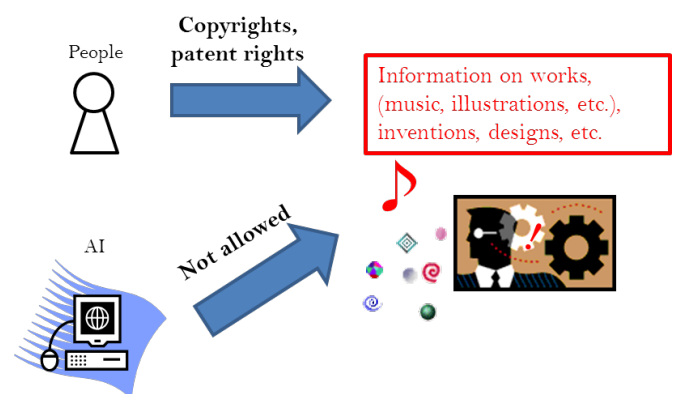

Ways of dealing with the creations of AI

Source: Created by MEXT based on materials used by the Committee on Next-generation IP Systems

well as the impacts of AI creations on the creative activities of people.

<3D printing for manufacturing innovation>

The use of 3D printing will make it easier to produce and distribute goods everywhere in the world. At the same time, fake goods will be also produced and distributed very easily. When goods protected as intellectual property are produced without the proper license, the act of production or distribution infringes on intellectual property rights. However, it is not possible to detect the production or distribution of every fake product, because 3D printing makes it very easy to produce fake goods.

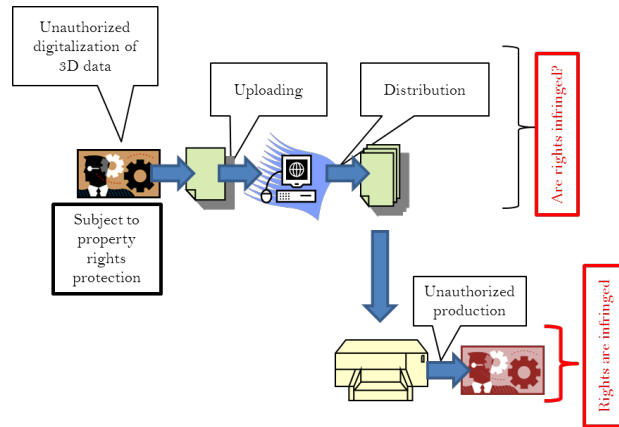

3D printing and the intellectual property system

Source: Created by MEXT based on materials used by the Committee on Next-generation IP Systems

Thus, regarding products protected under the intellectual property system, focus is being placed on the 3D data and not on products that are generated and/or distributed without proper licenses. From the viewpoint of the need to maintain the proper balance between the protection of intellectual property rights and the creation of innovations, deliberations are under way to determine whether the creation and distribution of 3D data on products protected as intellectual property should be subject to the intellectual property system.

③ Solutions to issues concerning the responsibilities of manufacturers and service providers

Various issues related to liability for incidents caused by AI robots need to be considered in a super smart society. For example, who is responsible for an accident caused by an AI that has acted against the will of the people concerned? A self-driving car is used as an example to

Definitions of driving safety support systems and automated driving systems
 <Replacement of the driver in the vehicle by the system>

Category of system	Description	Notes (responsibility, etc.)	The system that realizes the left-hand items	
Type of information provision	Alert given to the driver, etc.	The driver	Driving Safety Support System	
Automatic control system	Level 1: A single-function system	The system accelerates, steers or brakes.	The driver	
	Level 2: A multi-function system	The system accelerates, steers and brakes.	The driver Note: The driver is responsible for monitoring the system and for taking control from the system when necessary.	Semi-self-Driving System
	Level 3: An advanced system	The system accelerates, steers and brakes. The driver operates the vehicle only when requested by the system.	The system (under autonomous driving) Note: The system conducts autonomous driving in certain traffic environments (autonomous driving mode). Note: In autonomous driving mode, the driver is not responsible for monitoring the system (until the system requests that the driver take control).	Autonomous Driving System
	Level 4: Exclusive autonomous driving	The system accelerates, steers and brakes. The driver does not do anything.	The system Note: The autonomous driving system operates the vehicle for the entire journey.	Exclusive Autonomous Driving System

Note 1: The driver can override the system at any level, at any time.
 Note 2: Here, "the system" refers to the entity that replaces the natural driver in the cabin. The system can include not only the vehicle itself but also the apparatuses in the environment that controls the vehicle.
 Note 3: At Level 3, it is assumed that the driver is not responsible for monitoring operation by the system. Therefore, to realize Level 3, regulations and social systems, including social acceptance, need to be studied.
 Note 4: At Level 4, the system becomes completely different from conventional automobiles, which are based on a natural driver in the cabin. Social systems will be radically changed in terms of mobility services and automobiles. Thus, towards the introduction of Level 4, studies must address societies where such autonomous vehicles operate on public roads, including the social acceptance of such a system.

Definitions of driving safety support systems and automated driving systems

Source: *Public-Private IT'S Initiative/Roadmaps 2016: Toward the Realization of Automated Driving on Highways and Unmanned Autonomous Driving Transport Services in Limited Regions by 2020*, The Strategic Headquarters for the Promotion of an Advanced Information and Telecommunications Network Society (IT Strategic Headquarters), May 2016

elaborate on this issue below.

Autonomous driving systems are classified into four levels of autonomy¹. In a Level 3 self-driving car, for example, acceleration, steering and braking are autonomously controlled, and the driver's operation is needed only when required by the autonomous driving system. The driver's culpability for a car crash is basically determined on the basis of the predictability and preventability of the crash. Thus, it is critical to identify the direction of specific technology development that is necessary to ensure the unfailing transfer of responsibility for the handling of the car between the autonomous driving system and the driver. Responsibility for traffic accidents that involve self-driving cars needs to be considered in the light of the Road Traffic Act and the applicability of other relevant laws.

When self-driving cars travel on roads, the driver's responsibility will be partly assumed by the autonomous driving system. Accidents involving self-driving cars are expected to have various complex causes in addition to actions by drivers and automakers, therefore the liability for such accidents needs to be carefully specified. Such additional causes include failure to update map information in autonomous driving systems and system malfunctions due to hacking.

In October 2015, the National Police Agency, together with external experts, started deliberations on legal and other issues that need to be addressed toward realizing autonomous driving systems. The Agency is to formulate and release *A Guideline on the Verification Testing of Autonomous Vehicles on Public Roads* by the end of 2016. With the aim of safely and appropriately implementing experiments of self-driving cars on public roads, the Guideline will state key points to note for ensuring road safety and the smooth flow of traffic.

"Fully autonomous vehicles" (i.e., Level 4 autonomous driving systems) will be totally different from what people around the world expect of "cars"; thus, it is necessary to give consideration to social receptivity as well as to institutional frameworks before introducing fully autonomous driving systems. For this purpose, citizens' attitudes toward unmanned autonomous driving need to be analyzed. In connection with this, a questionnaire survey was conducted with the aim of understanding how people from all walks of life accept and think about the testing of autonomous vehicles on public roads.

④ Infrastructure improvements necessary for ensuring a high level of security

With the rise of the IoT, the number of devices connected to the Internet is expected to surge to over 25 billion² in 2020. The Internet of Everything will

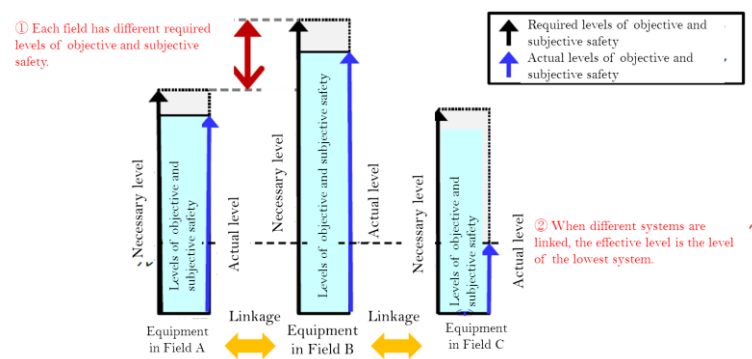

Safety and security levels that differ from sector to sector

Source: Ubiteq, Inc.

¹ The Strategic Headquarters for the Promotion of an Advanced Information and Telecommunications Network Society (IT Strategic Headquarters). Public-Private ITS Initiative/Roadmaps 2015: Strategies on Automated Driving Systems and the Utilization of Road Transport Data to Build a Society with the World's Safest and Smoothest Road Transport. June 30, 2015

² Gartner. Forecast: Internet of Things, Endpoints and Associated Services, Worldwide, 2014. October 20, 2014

benefit our lives in many ways, but it will also lead to increases in malicious cyberattacks. The safety and security required of devices connected to the Internet differ from sector to sector. Some devices are used online without their cybersecurity being ensured. Such a situation will result in significant problems, such as information leaks from virus-infected devices. Life-threatening accidents might be caused by hijacked devices that are part of in-vehicle systems or medical equipment.

The risk of becoming targeted in a cyberattack has been increasing rapidly in recent years. According to the National Police Agency, the access to TCP¹ port 23 with Telnet², a protocol used for remote device control over network, has remained at a high level since 2014³. A majority of the increased traffic is from devices connected to the Internet, such as routers, webcams, network-attached storage devices and digital video recorders. These devices are likely to be hijacked and exploited by cyberattackers.

Japan depends heavily on overseas manufacturers for cybersecurity products. Domestic cybersecurity technologies need to be enhanced, particularly because Japan should ensure safety and security for the 2020 Olympic and Paralympic Games in Tokyo.

Against this backdrop, in November 2015, the Council for Science, Technology and Innovation (CSTI) adopted “cybersecurity of critical infrastructure” as a new issue to be addressed under the Strategic Innovation Promotion Program (SIP). Efforts for ensuring the cybersecurity of critical infrastructure aim at creating systems that keep critical infrastructure free from malicious programs and that instantly detect malicious device operations. Specifically, in order to ensure the reliability of devices with respect to integrity⁴ and authenticity⁵, technologies will be developed for identifying illegal functions incorporated in control and telecommunications devices, monitoring illegal operations and analyzing operational logs. These technologies will be extended to IoT systems, and institutional arrangements will be examined for

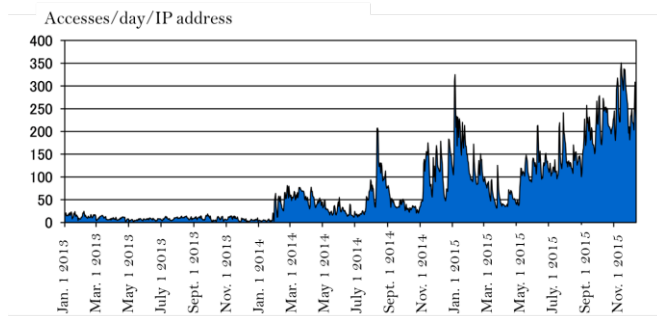

Increase in traffic using TCP port 23

Source: National Police Agency

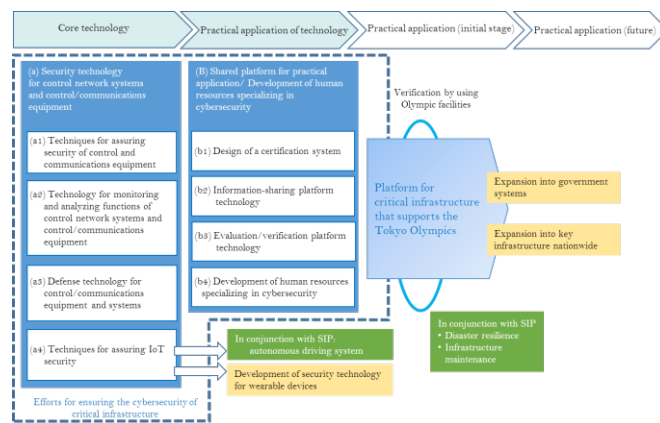

Outline of the Cyber-Security for Critical Infrastructure (SIP)

Source: Cabinet Office

¹ TCP stands for Transmission Control Protocol. It is a protocol or software for running the protocol that is used for remote computer control over a network.
² Telnet stands for "telecommunications network." It is a protocol or software for running the protocol that is used for remote computer control over a network.
³ National Police Agency. Observed attacks on IoT devices. December 15, 2015
⁴ Integrity: The control and telecommunications devices that make up an infrastructure control network are constituted as per specifications, have not been altered and have no illegal functions installed.
⁵ Authenticity: None of the control and telecommunications devices that make up an infrastructure control network have been replaced with illegal devices since the start of operation.

supporting the introduction of these technologies. Additionally, human resources specializing in cybersecurity will be developed.

In addition to the key infrastructure, the security of all systems that make up and support a super smart society must be ensured on the basis of the “security by design” concept from the ground in order to be secure.

(2) System reforms necessary for realizing a super smart society

In a super smart society, innovative products, services and business models that utilize ICT and robots will be made available. This suggests that people might face “gray zone” incidents or circumstances that are impossible under current systems/rules that were created on the basis of conventional technologies. To ensure that the creation of innovations leading to unprecedented “game changes” is not disturbed, existing systems need to be reviewed and reformed. When field tests are required for special zone systems and other systems must be used for making the necessary arrangements.

Efforts for regulatory reform and the promotion of special zones in a super smart society are summarized below.

① A super smart society and regulatory reform

Regulatory and institutional reform will be necessary as we move toward a super smart society. The Japanese government has been working on this issue as described below.

In June 2015, the Council for Regulatory Reform released “The Third Report by the Council for Regulatory Reform - Toward a Japan Full of Diversity and Vitality”. Based on this report, the “Implementation Plan for Regulatory Reform” was decided by the Cabinet. This plan consists of the following five major policy areas: health and medical care, employment, agriculture, investment promotion, and regional revitalization. In reform items are specified in these policy areas. “The establishment of a new radio wave utilization system” and “the establishment of rules concerning uninhabited airborne robots” are included in investment promotion, and these are closely related to efficient and effective maintenance and renewal of infrastructure. “The operation of mobility robots and unmanned agricultural machinery on public roads” is also a reform item for investment promotion, and it is connected to intelligent transport systems.

In the Public-Private Dialogue towards Investment for the Future, held in November 2015, private companies proposed that the issues to be addressed on regulatory reform to realize the following: autonomous driving systems, the transport of goods by drones, the long-distance remote control of construction machinery and drones, and a medical diagnosis support system. Prime Minister Abe instructed the cabinet ministers to start deliberations on relevant regulatory reforms (Figure 1-2-19).

In the First IoT Lab Selection conducted in February 2016, ten companies¹ out of the sixteen final candidates hoped for regulatory reform.

In a super smart society, innovations will be created at a much faster pace than now. The comparative advantage of a country depends heavily on how fast ideas and technologies are translated into practical

¹ Four of these ten companies wanted rules to be developed and regulatory reform to be implemented once they established their business models.

businesses and on how society works to make such translation possible.

■ Figure 1-2-19 / Objectives presented in the “Public-Private Dialogue towards Investment for the Future” of Nov. 5, 2015

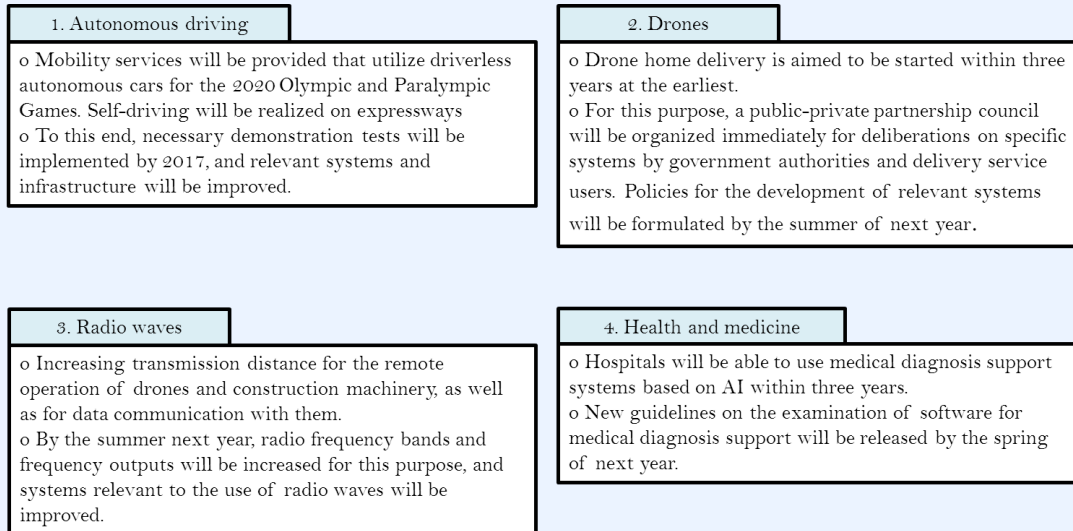

Source: Created by MEXT based on-the “Public-Private Dialogue towards Investment for the Future” of Nov. 5, 2015





In this regard, Japan should be ahead of the rest of the world in reviewing and reforming the systems that hinder the commercialization of new products and services, as well as in applying new business models so that these problems do not interfere with innovation and so that Japan can attract investment in innovation.

② A super smart society and special zones system

In addition to regulatory reform, a special zones system is useful for facilitating field tests for technology verification. Some examples of special zones where efforts toward realizing a super smart society have been made are shown below.

Japan has a system for designating “national strategic special zones,” “comprehensive special zones” and “special zones for structural reform” (Figure 1-2-20).

■ Figure 1-2-20 / Outline of the different types of special zones

Special zone	National strategic special zone	Comprehensive special zone		Special zone for structural reform
		Comprehensive special zone for international competitiveness	Comprehensive special zone for local revitalization	
Aim	Improving business environments for strengthening the international competitiveness of industries	Developing hubs of industries and activities that serve as engines of economic growth	Utilizing local resources for regional vitalization and for the enhancement of regional strengths	Promoting structural reform and regional vitalization through deregulation
Act for enforcement	Act on National Strategic Special Zones	Act on Comprehensive Special Zones		Act on Special Zones for Structural Reform
Year started	2013	2011		2002
Initiative	The Prime Minister	the region		the region
No. of certified zones (as of the end of March 2016)	10 zones	7 zones	41 zones	1,264
Support provided	Deregulation; taxation/financial measures	Deregulation; taxation/financial measures		Deregulation
Example	<p>"Use of Special Provisions of the City Planning Law" (Tokyo)</p> <ul style="list-style-type: none"> Regarding 22 urban redevelopment projects, ambitious urban plans and other predetermined matters are given priority in decision-making by the special zone conference for the purpose of speedy project implementation.  <p>Source: Website of Tokyo Metropolitan Government</p>	<p>Special Zone for Asian Headquarters (Tokyo)</p> <ul style="list-style-type: none"> Effective corporate tax rates will be reduced in order to attract foreign businesses to this special zone so that the zone will be a center of business or an R&D center in Asia for many companies.  <p>Source: Website of the Secretariat for Promoting Overcoming of Population Decline and Vitalization of Local Economy in Japan, Cabinet Office</p>	<p>Special Zone for Next-generation Automobiles and Smart Energy (Saitama City)</p> <ul style="list-style-type: none"> Hyper energy stations and low-carbon personal mobility will be increased toward developing a sustainable "Future-ciry".  <p>Source: Website of the Secretariat for Promoting Overcoming of Population Decline and Vitalization of Local Economy in Japan, Cabinet Office</p>	<p>Special Zone for Robot Experiments at Haneda Airport (Tokyo)</p> <ul style="list-style-type: none"> A demonstration project for single-passenger mobility-support robots traveling on public roads in and around Haneda Airport will be conducted.  <p>Source: Website of the Secretariat for Promoting Overcoming of Population Decline and Vitalization of Local Economy in Japan, Cabinet Office</p>

Source: Report on the Research and Analysis of Policy Issues Concerning the Promotion of "Science for Policy" of Science, Technology and Innovation Policies (research commissioned by MEXT in FY2015).

There are ten "national strategic special zones" as of March 2016. Progressive approaches taken in some of these special zones toward the utilization of autonomous driving systems and drones have been attracting increasing attention these days. These approaches are shown below.

< [Drones] A national strategic special zone: Efforts to promote the drone industry in the City of Semboku >

The City of Semboku, Akita Prefecture, aims at establishing a center for developing "near-future" industry by comprehensively supporting the fostering of highly skilled professionals and the launching of new businesses. For this purpose, the city conducted a drone demonstration flight in July 2015. In July 2016, the city hosted an international drone race. The City of Semboku was designated as a national strategic special zone, and as such it was allowed to take advantage of preferential measures to obtain, under the Radio Law, a short term experimental radio station license required to hold the race.

< [Drones] A national strategic special zone: Drone home delivery in the City of Chiba >

The City of Chiba, Chiba Prefecture, has been working on commercializing drone home delivery for the following reasons: to generate economic benefits by developing a cluster of high-tech industries and reducing delivery costs, and to improve the convenience of everyday life for elderly and families with small children. Specifically, within the framework of the national strategic special zone, the city established the Subcommittee on Drone Home Delivery in Chiba for intensive discussions on regulatory and institutional reforms necessary to address the following issues.

- The operator of an unmanned aerial vehicle (UAV) is not allowed to fly it in air space above approach surfaces around airports, more than 150 meters above the ground/water surface level, and above densely inhabited districts (Article 132, Civil Aeronautics Law, as amended in 2015)
- Every UAV should be operated in the daytime within Visual Line of Sight (VLOS) of the operator (Article 132-2, Id.)
- No radio frequency bands are allocated to UAV flights (pursuant to Article 26 of the Radio Law), and UAV operators can only use Wi-Fi frequency bands, as no license is required for the use of Wi-Fi frequencies.

The City of Chiba intends to collaborate with private businesses in conducting drone demonstration tests. For this purpose, the city will make use of preferential measures under the Radio Law under which time from application to issuing the license is shortened.

The eased regulations and drone demonstration tests are outlined in Figure 1-2-21.

■ Figure 1-2-21 / Drone home delivery in Chiba City

<p>Easing of regulations</p>	<ul style="list-style-type: none"> ✓ Exclusions from the no-fly zones stipulated in Articles 132 and 132-2 of the Civil Aeronautics Law, as amended in 2015, will be made. ✓ Operation of UAVs is allowed on the basis of ministerial authorization pursuant to the provisory clauses of Articles 132 and 132-2 above. ✓ UAVs can be operated in air space above densely inhabited districts according to ministerial notice, on the condition that consensus is obtained from the residents of these districts and safety measures are secured. ✓ The validity of flight plans is extended from the current 90 days (or 1 year) to 5 years. ✓ Radio frequency bands are exclusively allocated to commercial UAV flights.
<p>Field tests</p>	<p>【Home delivery and security by means of drones that utilize advanced technologies】</p> <ul style="list-style-type: none"> ✓ From the distribution warehouses in waterfront areas along Tokyo Bay near Makuhari Shintoshin to a distribution center in Makuhari Shintoshin, drones fly as high as 10km above the sea or the Hanami River (a class A river). From the distribution center, drone home delivery is available to residents of condos in the area around the distribution center. This test demonstrates that drones can fly 10km above non-residential areas in an urban district. ✓ Drones are used for providing security against prowlers and intruders.

Source: Created by MEXT

< [Autonomous driving systems] A national strategic special zone: Project for fully autonomous driving >

To develop technologies for fully autonomous driving (i.e., Level 4 autonomous driving systems), it is necessary to conduct field tests adequately and to verify the test results. Toward this, arrangements have been made for tests at special zones. These tests need to be implemented actively and safely on public roads for the collection of data on the safety of autonomous driving systems with the aim of attaining Level 4¹.

¹ The Japan Revitalization Strategy as revised in 2015 (approved by the Cabinet on June 30, 2015); Public-Private ITS Initiative/Roadmaps 2015 (adopted by the IT Strategic Headquarters on June 30, 2015).

The Japanese government should deliberate on revisions to international treaties that relate to fully autonomous driving systems. On the basis of data from testing on public roads, the government should also examine various issues for the early realization of fully autonomous driving. These issues include amendment of the Road Traffic Law, liability for car accidents, and drivers' obligations.

Autonomous driving field tests were conducted in the Shonan district, such as the City of Fujisawa, which is a national strategic special zone. Field tests were also implemented on public roads and at a site in a disaster hazard area (the Arahama district) in the City of Sendai, which was devastated by the Great East Japan Earthquake. The eased regulations and drone demonstration tests are outlined in Figure 1-2-22.

■ Figure 1-2-22 / National strategic special zone project for realizing fully autonomous driving

Field tests	<p>【Projects for fully autonomous driving (i.e., Level 4 autonomous driving systems)】</p> <ul style="list-style-type: none"> ✓ A project was implemented in the Shonan district, which includes the City of Fujisawa, from Feb. 29 through Mar. 11, 2016. About 50 local residents were transported over a distance of 3km on arterial roads. ✓ A project was implemented in the Arahama district of the City of Sendai on Mar. 27, 2016. A driverless driving test was conducted in the schoolyard a former elementary school. A driving test was conducted by using GPS on public roads.
--------------------	---

Source: Created by MEXT

Column 1-8

Autonomous driving system: New value generated through the development of 3D location information infrastructure

The Council on Competitiveness-Nippon (COCN) has been working on the development of high-accuracy 3D location information infrastructure for shared use by multiple sectors. Based on examinations from the viewpoints of mobility, robotics, disaster prevention, navigation technology and social infrastructure, the COCN proposed that the shared 3D location information infrastructure consist of “3D laser scanning point clouds,” “camera images” and “basic data on road configuration.” The COCN suggested absolute location accuracy of 10-30 cm and relative location accuracy of about 1 cm. One service offered on the basis of this advanced 3D location information infrastructure is dynamic maps used for autonomous driving.

In an autonomous vehicle, the AI instantaneously compares in-vehicle map information and sensor information and deems differences between them to be moving objects. Because dynamic maps are 3D maps, the gradients and curves on the road ahead, in addition to lanes, are recognized in advance of the vehicle on the basis of gradient data, elevation data, etc.



The use of a high-accuracy map for supporting safe autonomous driving

Source: COCN. Final Report on “Services Utilizing 3D Location Data and Development of Shared Infrastructure”

The private and public sectors have both been implementing autonomous driving projects, including a project for autonomous driving systems under the Strategic Innovation Promotion Program (SIP) of the Cabinet Office. Prime Minister Abe took a self-driving car for a test drive on a public road near the Diet Building in November 2013. Since then, technological advances have been made steadily. In 2013, a sensor was mounted on the roof of a self-driving car. Presently, R&D is being conducted to achieve all-around visibility by attaching three compact sensors to the front and three more to the rear of the car.

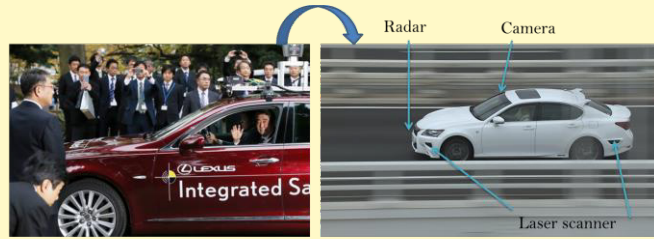

The test vehicle ridden by Prime Minister Abe in Nov. 2013

Rapid development of autonomous driving systems

Source: Cabinet Office

In contrast, autonomous driving on roads other than expressways is technologically challenging. Because sensors need to recognize a lot of information about pedestrians, bicycles, motorcycles, traffic signals and the like, R&D is necessary to establish camera technology for detecting people and algorithms to avoid false detection.

Diverse technologies are required for realizing autonomous driving on roads but at the same time, cooperation and competition are important for leading the world in the advancement of autonomous driving technologies. While various companies need to compete with each other on R&D for in-vehicle sensors and artificial intelligence, industry-academic-government cooperation is necessary for promoting R&D concerning information security, shared guidelines and dynamic maps consisting of digital maps and information acquired through communications.

3 Paradigm Shifts in Scientific Research

Advances in ICT are bringing innovation to scientific research.

The growth of the Internet has made it easier for scientists to exchange scientific knowledge and findings by publishing research results online. In addition, scientists can work together online regardless of time and place. The Internet also encourages citizens to be actively involved in scientific research. Thanks to advances in big data analysis technology and artificial intelligence, research can be conducted effectively by referring to vast amounts of academic information generated by other scientists. Big data and artificial intelligence facilitate tasks that are difficult for scientists to complete by themselves. Thus, they help boost research productivity. How scientists undertake research has changed.

Some of the new research methods are described below.

(1) New research methods made possible by information and communications technology

A lot of scientific discoveries have given people a whole new perspective on the world, and have helped them improve their lives. Experiments and contemplation by scientists have led to these discoveries, and there have been no significant changes in the research methods used by scientists. However, the development of technologies for artificial intelligence and big data analysis is causing changes in research methods. These changes are not clearly visible now, but are surely taking place.

① Online collaboration and citizen participation

The spread of the Internet has made it possible for scientists to try new research methods by utilizing online networks and digital tools.

For example, Tim Gowers, a British mathematician, started the Polymath Project¹ in 2009 by using his blog for collaboration among mathematicians to solve important and difficult mathematical problems. With the idea that, “if a large group of mathematicians could connect their brains efficiently, they could perhaps solve problems very efficiently as we,” Gowers asked his readers to take part in the project. Project participants look at progress on the solutions to problems recorded in the comments section of Gowers’ blog when they need to do so, and advance their own work while being inspired by the ideas of mathematicians somewhere far away. Gowers’ initiative has been quite successful. Papers on the proofs of mathematical theories, and solutions to difficult problems proposed by Gowers, have been published by an anonymous author representing all the participants involved. The Polymath Project is an example of collaborative research that is considerably more productive than research conducted by an individual researcher. In this research method, the ideas of different researchers are efficiently connected with each other because these researchers gain insights from each other.

Galaxy Zoo² is a good example of citizen science that has been actively pursued since the advent of the Internet. In this online citizen science project, millions of galaxy images from the Hubble Space Telescope are classified. More than 200,000 citizens have been supporting this large-scale galactic research project. Some Galaxy Zoo volunteers, who have discovered new types of galaxy, are listed as coauthors of scholarly publications. Thus, this project has been encouraging citizens to play active roles in scientific research. In advanced scientific research, each scientist tends to focus on a specialized area that is very limited in scope. In contrast, many scientific discoveries are made when knowledge and ideas from different research areas interact. The spread of scientific research by citizens seems to provide scientists with opportunities to turn their eyes to issues beyond their own areas of expertise and thus to find something that could lead to new discoveries.

The importance of the research methods described above is that individuals’ ideas are



Classification of galaxies according to their shapes

Source: Galaxy Zoo.

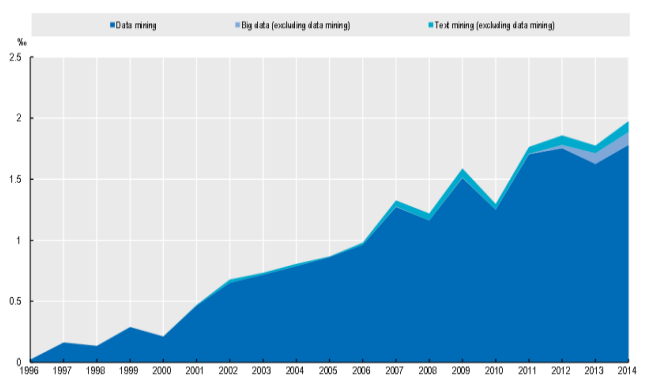

The number of papers on data analysis technologies

Source: Measuring the Digital Economy: A New Perspective, (2014 OECD Publishing)

DOI: <http://dx.doi.org/10.1787/9789264221796-en>

¹ <http://polymathprojects.org/>

² <http://www.galaxyzoo.org/>

shared before they are used to produce research results, whereas in the conventional research methods, findings are shared only when research papers are published. These new research methods suggest the possibility that ways of conducting research will change from the current practice of focusing on research article publication.

② Data-driven research

Data-driven research has been attracting attention as a new research method based on the large capacity available for processing vast amounts of diverse data. In data-driven research, the discovery of a scientific law is driven by large amounts of unstructured data and is used to advance research. This research method emerged because the amounts of publicly available data have increased at an accelerated pace, the majority of data useful to scientific research is now available in machine-readable formats, and the amount of data accumulated through various studies has reached a level sufficient for data-driven analysis.

One example of data-driven research is materials search in materials science. Materials search aims at improving the characteristics of a specific material or discovering an alternative material. It used to depend on experiments that were

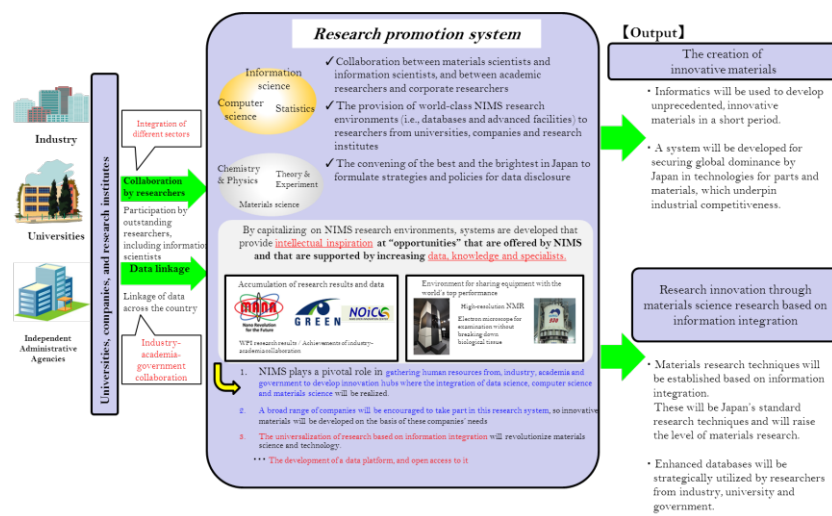

The enhancement of data-driven materials R&D

Source: Created by MEXT

conducted by using researchers' intuitions or personal experiences, and data from experiments needed to be accumulated in the search for materials. Such a conventional method requires huge amounts of time and money. This problem is solved by using materials informatics. Materials informatics is a field of study in which data on chemical compounds are analyzed in a search for new materials. This approach is highly promising. The National Research Council of the National Academies of Sciences, Japan stated in its 2008 proposal: "Integration of computational techniques and information analysis techniques that are related to materials research will reduce the materials development cycle from its current 10 to 20 years to 2 to 3 years." In the U.S.A., "the Materials Genome Initiative" was started in 2012 in order to accelerate materials discovery and deployment. In Japan, under the "Materials research by Information Integration Initiative (MI²I)" launched in 2015, the National Institute for Materials Science (NIMS) has been working on developing research infrastructure for materials informatics. Materials informatics in Japan began to produce results. In November 2015, Atsuto Seko, Associate Professor at Kyoto University, succeeded in the discovery of efficient low-thermal-conductivity compounds by utilizing techniques of materials informatics.

In the Advanced Integrated Intelligence Platform (AIP) Project, R&D will be implemented to enhance

the rapid progress of scientific research. For this purpose, support will be provided for scientific discoveries that are made not only through theories and experiments but also by applying innovative artificial intelligence technologies to big data (i.e., the 5th scientific technique, or AI-driven science; in addition to theories, experiments, simulations, and big data analysis).

In data-driven research, meaningful results are produced from vast amounts of data that humans alone cannot fully analyze. The quality of research results depends on the availability of quality databases. Thus, to promote data-driven research, numerous useful databases need to be made available.

(2) Open science

The release to the public of research results in the form of articles and data is expected to help with knowledge accumulation, the fairness and transparency of research activities, collaborative research, and innovation. In the 15th century, the invention of typographic printing dramatically boosted information distribution, and the publication of research results increased, thereby greatly advancing scientific research. Recent advances in ICT are said to have an impact similar to the impact of the printing revolution on scientific research.

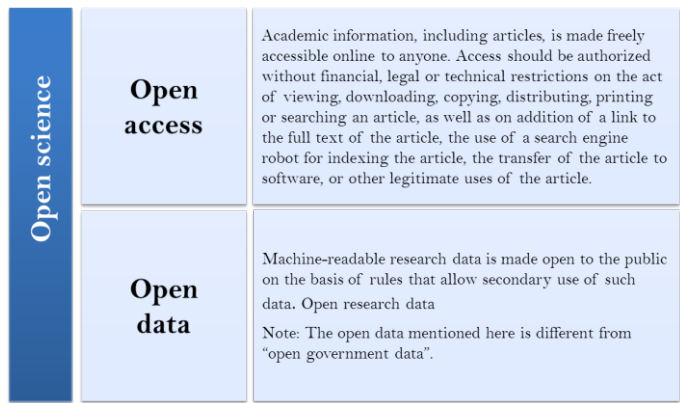

The concept of open science

Source: Created by MEXT

Efforts have been made to enhance open access to academic information such as academic articles and to increase the open data, i.e., the free availability of data to the public. The open science concept encompasses open access and open data. It opens up a new way of creating knowledge, and it effectively promotes research on science and technology. Open science provides a new way for scientific research to achieve innovations.

Not only scientists, but also many stakeholders from various sectors are involved in releasing research results. The ideal way of conducting open science needs to be discussed carefully. Efforts to promote open science are a topic of vigorous discussion in many countries. It is important for Japan to take part in such discussion and to show its proactive attitude toward open science.

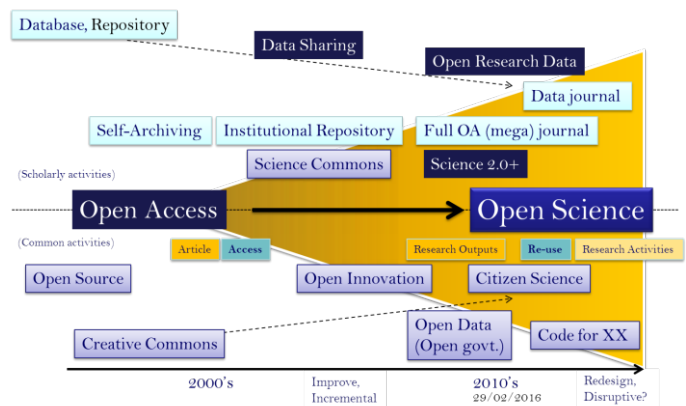

Trends in open science

Source: Adapted by MEXT from the original made by the Cabinet Office

① Background to and issues of open science

In scientific research, a hypothesis made by a researcher needs to be logically verified based on evidence, and the conclusion obtained from the hypothesis needs to be validated by other scientists. Thus, it is essential for researchers to share information necessary for replicating the validation process, and articles are important for this purpose. By releasing articles, researchers can demonstrate their groundbreaking contributions. Establishing oneself as a pioneering researcher is a major incentive for researchers to publish research. With the growth of the Internet, repositories of electronic preprint server, such as arXiv¹, have been made available, and an increasing number of researchers have released preprints online before publishing postprints in academic journals. While it is urgently necessary to do something about the rising cost of academic journal subscriptions, a controversial issue has arisen regarding the copyrights of papers that are shared by researchers on social networking website for academics such as Academia.edu. The Japanese government aims to release the results of publicly funded research to the public.

There are some initiatives for releasing for public use not only academic papers, but also all data used in research. Efforts have been made to promote open data with the aim of verifying research results that are increasingly produced by using data-driven analysis and for the purpose of enhancing research productivity by re-utilizing data that are freely available. Open data need to be machine-readable so that the data can be used for data-driven analysis. Open data are useful for validating research results more accurately than before, as well as for saving data maintenance costs by avoiding the need to store data at multiple sites. Consequently, the fairness and transparency of scientific research will be secured. In light of this, it is necessary to develop systems for the quality evaluation and publication of data based on the peer review process in forums the same as for academic papers.

As the importance of data for researchers has been increasing, a venture that was started in 2014 by researchers at the University of Tokyo developed software for detecting image manipulation and plagiarism in research papers. New businesses like this venture have been created as a result of the above-mentioned changes in the distribution of academic information. At the same time, efforts for increasing open data and open access have caused changes in research-related businesses, including the publication of academic journals.

It has been pointed out that researchers who contribute to generating and collating data in large-scale experiments are underappreciated. Usually, academic papers are the basis for evaluating researchers' scientific achievements. Besides, some systems are needed so that researchers can be evaluated on the basis of their contribution to research data. The importance of evaluating research results is also drawing increasing attention because of the need to promote globally competitive research as well as to secure the appropriate allocation of competitive research funds. Efforts aimed at diversifying evaluation methods are expected to encourage researchers and various research activities such as pursuing online collaborations, rather than to focus on writing papers. Recently, altmetrics, a new set of impact indicators, have been developed. Altmetrics are used for measuring the impact of published research results, including academic papers, from various angles. For example, the social impact of a paper can be immediately determined on

¹ arXiv.org e-Print archive(<http://arXiv.org/>)

the basis of citations on social media such as Twitter. Altmetrics are expected to complement traditional, citation-based metrics. In 2012, PLoS ONE, an open-access journal, started to list impact assessment indicators based on altmetrics, in addition to the conventional citation impact and the number of downloads for each article that the journal provides online. Altmetrics have been drawing attention, as shown by the BOAI 10 Recommendations¹ which state, “We encourage the development of alternative metrics.”

In a survey conducted in 2011, 84% of the researchers surveyed said they hoped to use data generated by other researchers if such data were easily accessible. However, only 36% of researchers surveyed made unprocessed data accessible to other researchers². Infrastructure needs to be developed for helping researchers to disclose their data securely. Such infrastructure includes a system based on an appropriate open or closed strategy, and incentives for disclosure of research data.

② The development of open science infrastructure

When open access to research results is realized in response to the needs of researchers and stakeholders, the vast amounts of information to be made available will enhance STI. Studies have been advanced for supporting the promotion of new research approaches.

In January 2004, science and technology ministers of OECD member countries agreed to the Ministerial Declaration on Access to Research Data from Public Funding. Based on the Ministerial Declaration, the OECD formulated the Principles and Guidelines for Access to Research Data from Public Funding in December 2006. In June 2013, G8 Science Ministers met and agreed that open scientific research data, publicly funded scientific research data in particular, should be easily accessible and usable. In May 2013, the Global Research Council (GRC) endorsed the Action Plan towards Open Access to Publications as a living document. The GRC is a virtual forum consisting of the heads of science and engineering funding agencies from around the world. Against such a background, RDA³ (the Research Data Alliance) and the ICSU⁴-WDS⁵ (World Data System) have been promoting discussions on open research data.

Based on various efforts for open research data, many countries are now making arrangements for the promotion of open science. For example, in 2011, the National Science Foundation (NSF) started to require all NSF grant applicants to submit a Data Management Plan that includes data, articles, samples, physical collections, software, models, or other materials produced in the course of the proposed research project. In Germany, the Copyright Law was amended in 2013. Pursuant to the amendment, the author of any scientific work produced during scientific research funded by public money and published in a periodical retains the right to make the accepted manuscript publicly available online after an embargo⁶ period of 12

¹ Recommendations for the coming 10 years which were made in 2012, the year the Budapest Open Access Initiative marked its 10th anniversary in February

² Tenopir, C., Allard, S., Douglass, K., Umur Aydinoglu, A., Wu, L., Read, E., Manoff, M., Frame, M. Data Sharing by Scientists: Practices and Perceptions. PLoS ONE 6, 2011, e21101.

³ The Research Data Alliance (RDA) is an international organization established in August 2012 with funds provided by the NSF (the U.S.), iCORDI (EU) and ANDS (Australia). The RDA aims at the researcher-led formulation of guiding rules for the distribution of research data.

⁴ ICSU: International Council for Science. This non-governmental organization was established in 1931 to promote international activities in the fields of science and science application.

⁵ The WDS officially came into existence through a decision at General Assembly of the International Council for Science (ICSU) in October 2008 for advancing global efforts related to scientific databases.

⁶ An embargo is a length of time that publishers of non-open-access journals can make authors of the articles published in the journals wait before they are allowed to make the articles available in repositories or through aggregators. (“Aggregators” are service providers that collect and sell e-books and e-journals in specific fields from multiple publishers.) The embargo on research articles gave rise to the idea that research results including the data should be made publicly available after a specified length of time, i.e., after an embargo.

months from the date of the first publication. This right is also retained in the case of a complete copyright transfer to the publisher.

As discussions on open science have deepened globally, Japan is required to contribute more actively to these discussions and to lead discussions cooperatively and strategically. Otherwise, a de facto global standard might be formulated without consideration for Japan's circumstances, and the advancement of scientific research in Japan might be restrained. In this regard, everyone involved in promoting science and technology needs to share a common view of open science in Japan.

In December 2014, the Cabinet Office started studies on open science in light of global trends in open science, and the results were summarized into a report in March 2015. The report specified the basic stance of the Japanese government for the promotion of open science, stating that Japan will further promote the use of the results of publicly funded research. Based on the report, the Science Council of Japan has been investigating and deliberating on the arrangements that Japan's scientific world should make for open science. Active discussions on open science have been conducted by government organizations. For example, the Science Information Committee under the Subdivision on Science, the Council for Science and Technology (CST), has examined open access to scientific articles and data used in these articles. To follow the progress of efforts made by ministries, agencies and government-affiliated organizations, the Cabinet Office convened the Follow-up Expert Panel on Open Science in July 2015 for deliberations on specific issues concerning the release of, and open access to, research data, as well as the storage of such data.

As part of the measures for promoting open access to scientific articles, in 2013, MEXT began to support the development of open-access journals under the Grants-in-Aid for Scientific Research Program. The JST has been operating J-STAGE (Japan Science and Technology Information Aggregator, Electronic), a platform for helping academic societies in Japan publish their electronic journals. Moreover, the National Institute of Informatics (NII) has been providing a shared platform and various services for encouraging universities to build and operate their own institutional repositories and for promoting the distribution of academic digital content.

Open science has tremendous positive impacts on scientific research. Additionally, the future advancement of ICT is likely to change the way scientific research is conducted. To create more stimulating and productive research environments towards a new era, aggressive actions should be taken in the face of new trends in scientific research. For that purpose, it is critical to ensure researchers' understanding the importance of such actions and to enlist the cooperation of others concerned. Proactive approaches are necessary to investigate the way future scientific research should be conducted.

Column
1-9

The development of image analysis software that supports the advancement of science and technology

With the advancement of research tools and increases in the release of academic papers, the amount of image data used in research has continued to increase. Because researchers tend to use many images for statistical analyses rather than using a limited number of images to show significant differences among them, the number of images that need to be dealt with has been increasing. Consequently, image processing and analysis for preparing academic papers as well as the peer review of images in these papers require much time and prevent researchers from concentrating on other essential research activities.

"Researchers should stop using time ineffectively and should use their time for creative work." That was the idea of the three researchers at the University of Tokyo who established LPixel Inc., a university-launched venture, in March 2014. This venture company has been applying its world-leading technologies to solve problems related to the use of big data, a salient issue in academia. For the benefit of life science researchers, the company offers various solutions by developing image processing/analysis software as well as applications based on technological seeds. In developing these software and technological applications, technical knowledge of life science and image analysis techniques are necessary. The number of specialists with both is limited; thus, LPixel does not have many competitors worldwide. The company aims at expanding its business globally. For this purpose, they are capitalizing on Japan's advantage over other countries in terms of the quantity of CT/MRI data for advancing research on medical diagnoses that utilize artificial intelligence and deep learning.

At the same time, the company has also been working on the issue of image manipulation and plagiarism in research papers. In April 2014, software for detecting manipulated images in academic papers was provided online for free by LPixel. This free software is expected to be used by many senior researchers who provide mentoring to younger researchers and by reviewers of academic papers. Thus, it will help deter image manipulation and plagiarism.

LPixels is a notable example of a business that evolved out of scientific research.

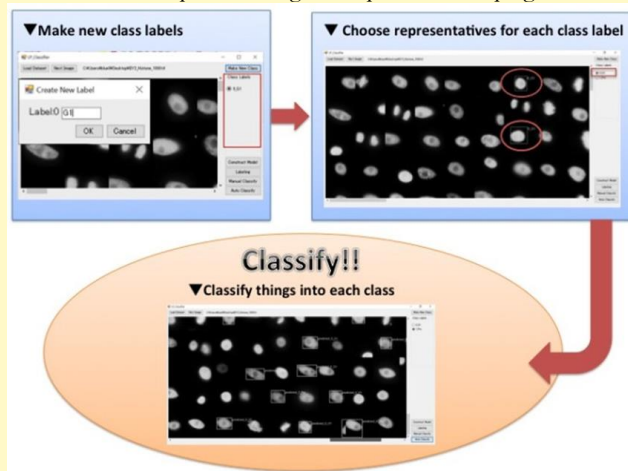

LP-Classifier: Software for automatic image classification using artificial intelligence and machine learning

Source: LPixel Inc.